

SERIAL NUMBER: Q/KR.C09-05-186

ZHONGSHAN HCF ELECTRONIC TECHNOLOGY CO., LTD			MODEL NO: P02-4			
DRAWN	DATE		EDITION	A	SCALE	1.8:1

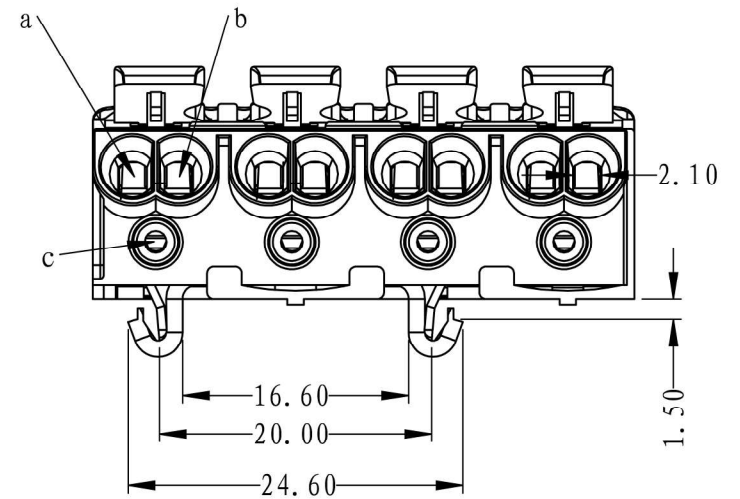
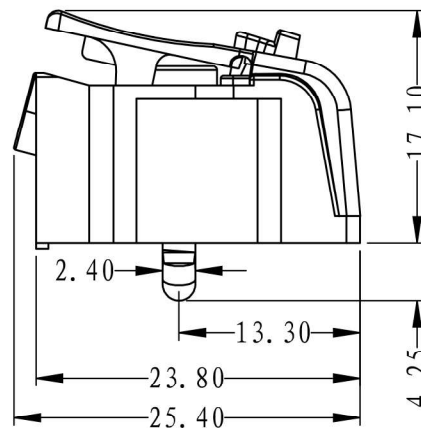
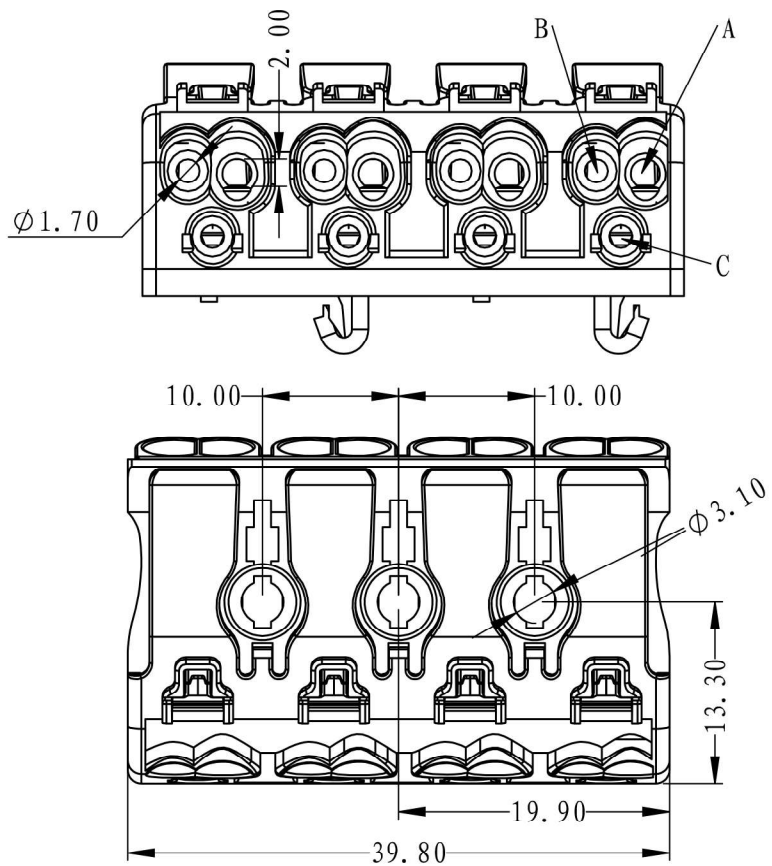
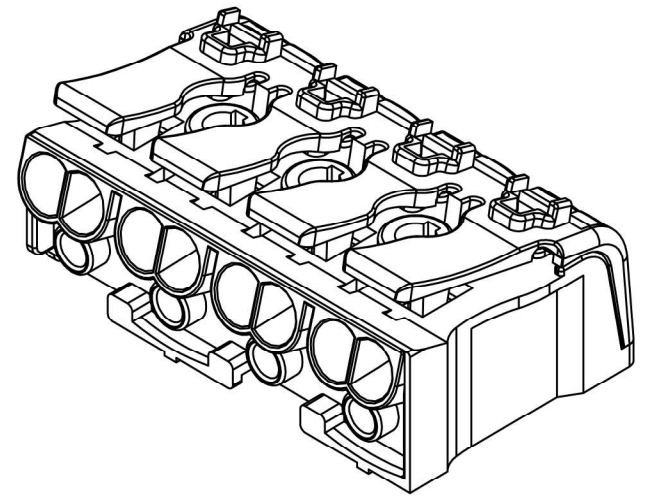
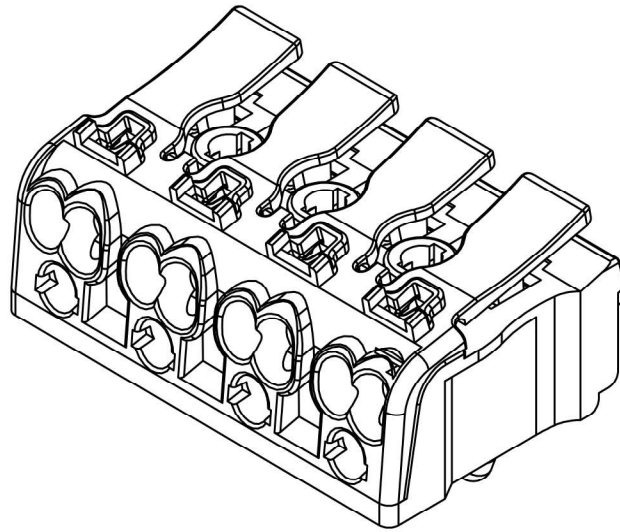
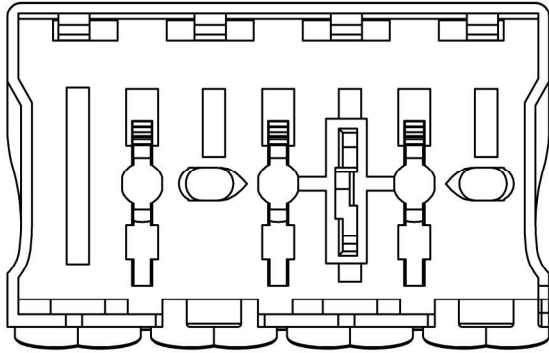

SERIAL NUMBER: Q/KR.C09-05-186

ZHONGSHAN HCF ELECTRONIC TECHNOLOGY CO., LTD			MODEL NO: P02-4J			
DRAWN	DATE		EDITION	A	SCALE	1.8:1